

**TRANSFORMER
(10 BASE-T)**

FEATURES

- Designed to meet or exceed IEEE 802.3, 10Base-T specifications
- Available with common mode chokes for EMI suppression
- Surface mount, IC grade, transfer-molded package withstands 235°C peak temperature profile

TEST CONDITIONS

- Inductance ----- 100KHZ/20mV
- Leakage Inductance ----- 100KHZ/20mV
- Interwinding Capacitance -- 100KHZ/20mV

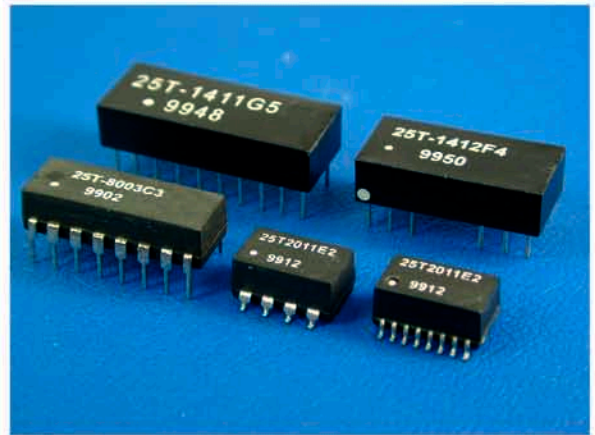

ELECTRICAL SPECIFICATIONS @25°C-Operating temperature 0°C TO 70°C

PART NUMBER	Turns Ratio (±5%)		Primary Pins	Common Mode Choke	Sine Wave Inductance OCL' (µH MIN)	Interwinding Capacitance CWW' (µF MAX)	Leakage Inductance LL' (µH MAX)	DCR (Ω MAX)	Hi-Pot (Vrms)	Schem.	mech.
	Transmit	Receive									
Surface Mount											
25T-1411A1	1:√2	1:1	3-4/1-2		140	12	0.2	0.4	2000		1
25T-2011E3	1CT:1CT	1CT:1CT	1-3/6-8		200	10	0.25	1.0	1500	E	3
25T-2011C3	1CT:1CT	1CT:1CT	1-3/6-8		200	10	0.2	0.3	2000	C	3
25T-1111D3	1CT:√2CT	1CT:1CT	6-8/1-3	X	110	15	0.4	1.0	1500	D	3
25T-1412C3	1CT:√2CT	1CT:1CT	6-8/1-3		140	12	0.2	0.3	2000	C	3
25T-2012C3	1CT:√2CT	1CT:1CT	6-8/1-3		200	15	0.5	0.4	2000	C	3
25T-2011F3	1CT:√2CT	1CT:1CT	6-8/1-3	X	200	12	0.5	0.6	2000	F	3
25T-1013C3	2CT:1CT	1CT:1CT	1-3/6-8		100	10	0.4	0.5	2000	C	3
25T-1411E3	2CT:1CT	1CT:1CT	1-3/6-8	X	140	12	0.3	1.0	1500	E	3
25T-1112D3	1CT:2CT	1CT:1CT	6-8/1-3	X	112	8	0.3	0.8	1500	D	3
25T-1114C3	1CT:2CT	1CT:1CT	6-8/1-3		112	8	0.3	0.5	1500	C	3
25T-1412F3	1CT:2CT	1CT:1CT	6-8/1-3	X	140	12	0.1	0.6	2000	F	3
25T-2012E3	1CT:2CT	1CT:1CT	1-3/6-8	X	200	12	0.3	1.0	1500	E	3
25T-1411B3	—	1:1(4X)	1-2/3-4		140	12	0.2	0.4	2000	B	3
25T-1412B3	1:√2 (4X)	—	1-2/3-4 5-6/7-8		140	12	0.2	0.4	2000	B	3
Through Hole											
25T-8003C2	2CT:1CT	1CT:1CT	1-3/6-8		80	10	0.4	0.5	2000	C	2
25T-1412C2	1CT:√2CT	1CT:1CT	6-8/1-3		140	15	0.5	0.4	2000	C	2
25T-2011C2	1CT:1CT	1CT:1CT	1-3/6-8		200	15	0.25	0.3	2000	C	2
25T-1412F4	1CT:1CT	1CT:1CT	1-3/6-8	X	140	15	0.3	0.3	1500	F	4
25T-1411G5	1CT:1	1CT:1	1-2/3-4 7-8/9-10	X	140	15	0.3	0.3	1500	G	5

SCHEMATICS

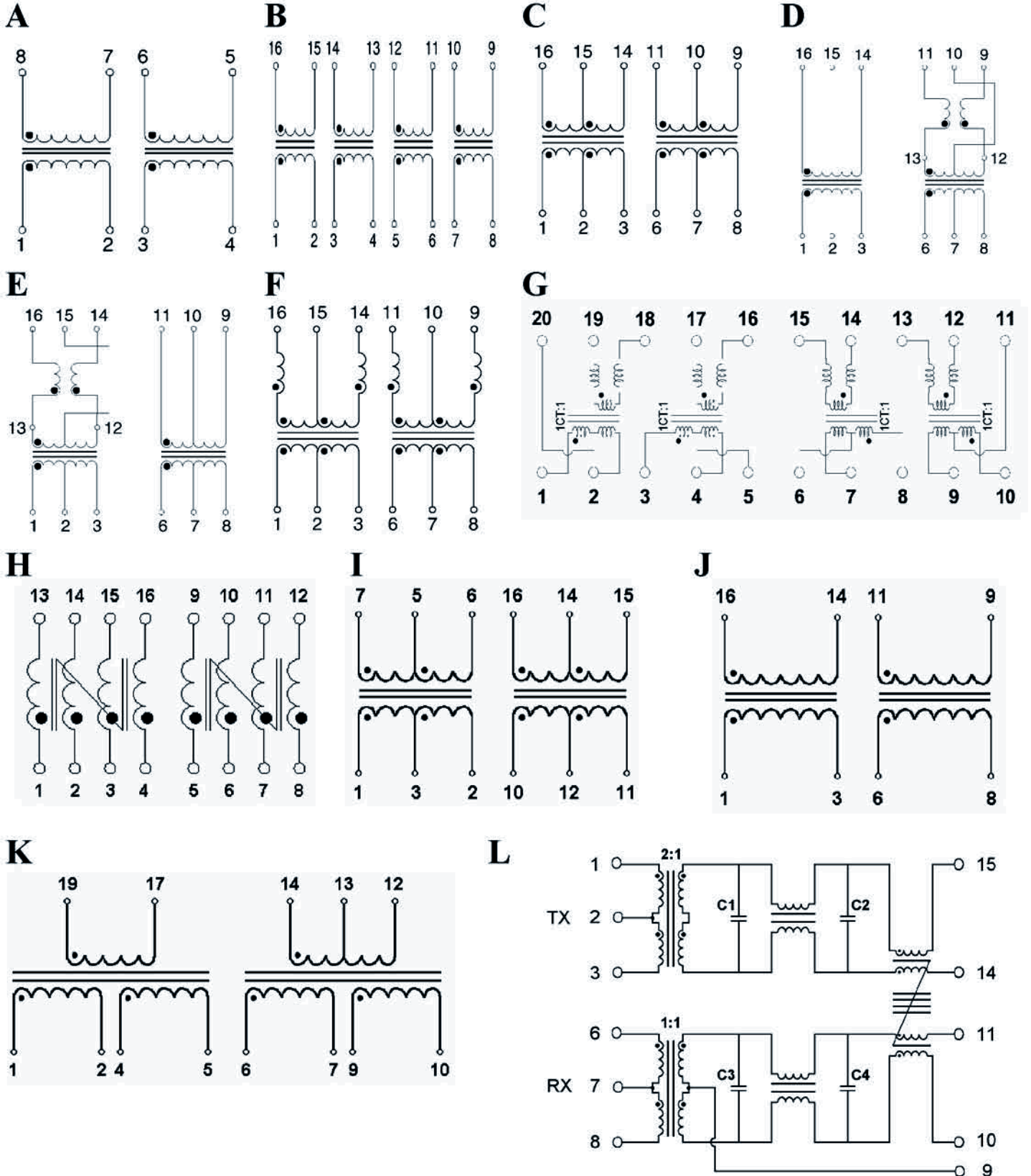

M

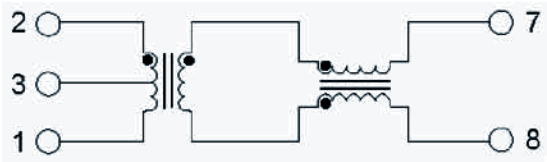

N

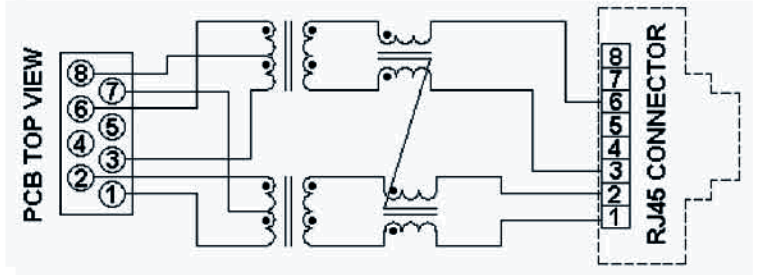

R

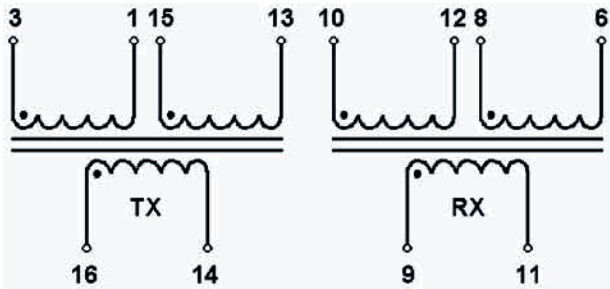

S

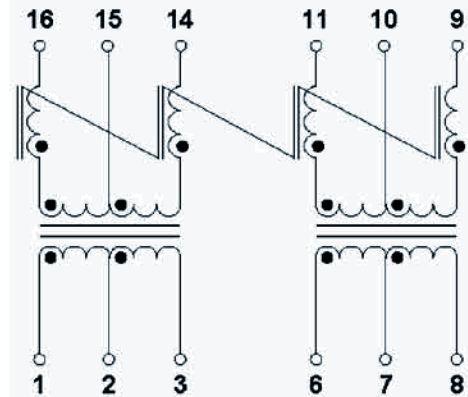

T

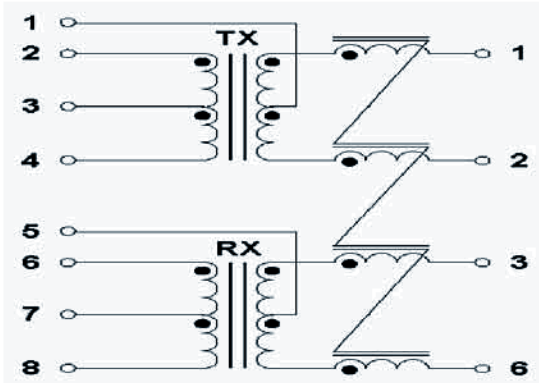

MARKINGS AND DIMENSIONS

1

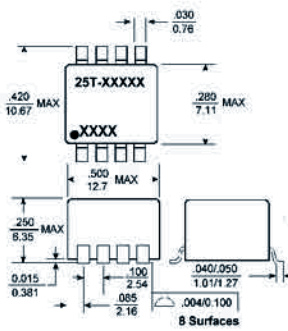

2

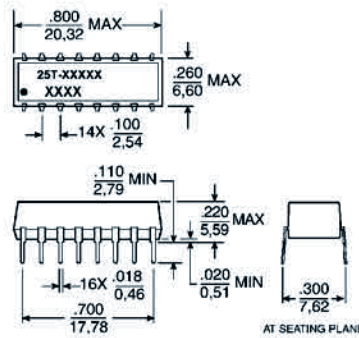

3

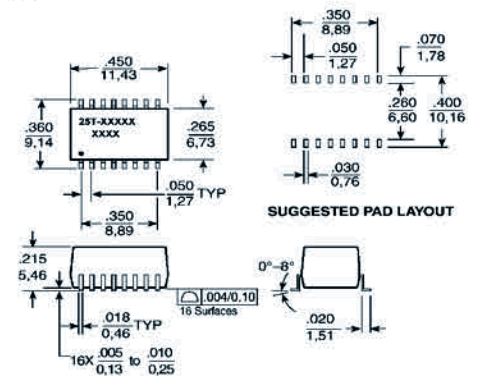

Dimensions: inches/mm Unless otherwise specified, all tolerances are $\pm 0.005/\pm 0.13$

4

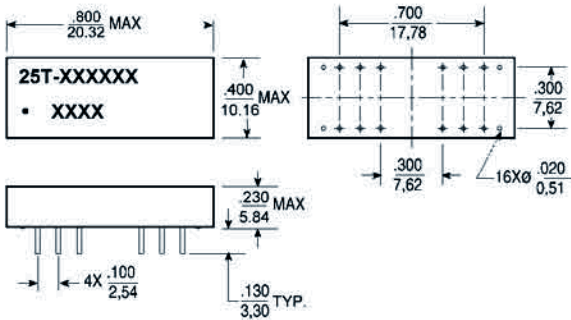

5

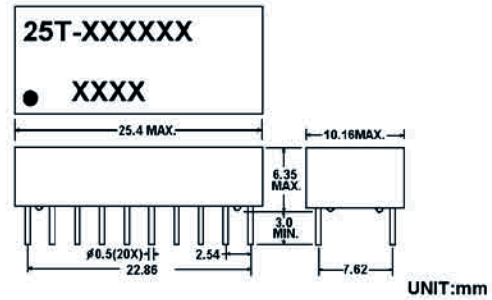

6

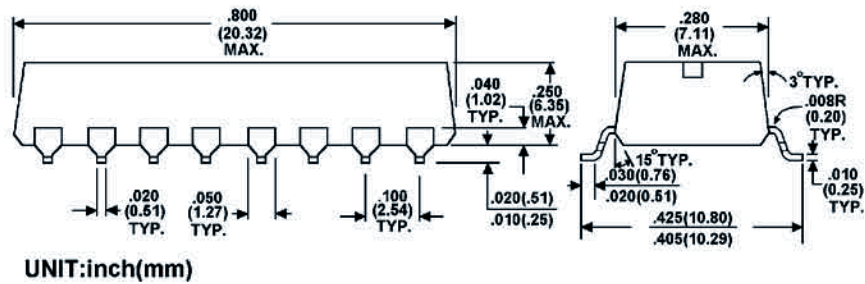

7

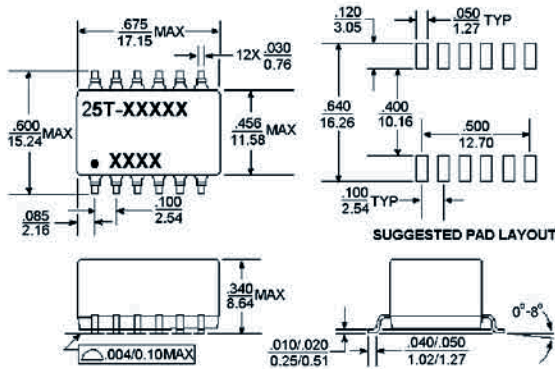

8

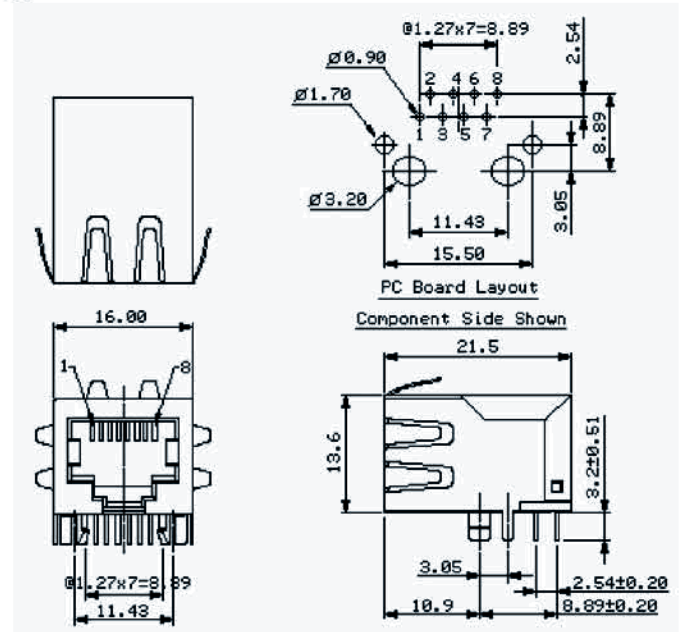

9

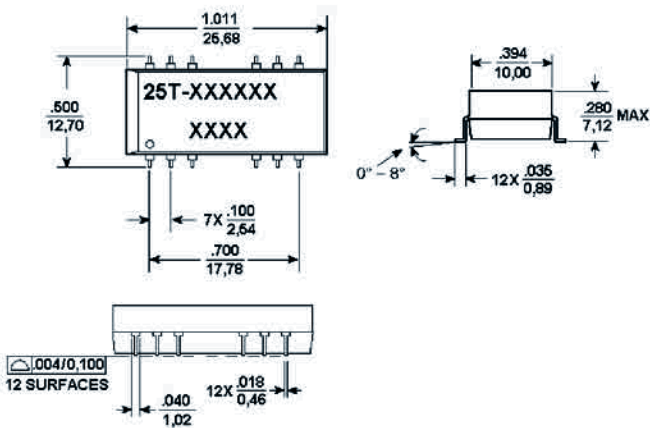

Dimensions:inches/mm Unless otherwise specified, all tolerances are $\pm .005/\pm 0.13$